



01
MAIN CATALOGUE



Power distribution boxes

ELECTRIC SOLUTIONS

V0126

Contents

Introduction

Introduction	3
--------------	---

Hard rubber power distributors

Type 1400	4
Type 1600	5
Type 1616	6
Type 2516	6
Type 2612	7
Type 2700	8
Type 2812	9
Type 3020	10
Type 3800	10
Type 3900	11
Type 4512	12
Type 7200	13-14
Type 7250	15
Type 7300	16-17
Type 7400	18-19
Type 7700	20-22
Type 7800	23
Type 7900	23

Suspended distributor

Suspended distributor, plastic	24
Suspended distributor, plastic with compressed air	24

Dimensions

Hard rubber power distributors types 1400 - 7900	25-27
Suspended distributor, plastic with compressed air	27

Frame

Frame	28
-------	----

Automated unit protective caps

Automated unit protective caps	29
--------------------------------	----

Suspension/mounting brackets

Aluminium brackets	30
V4A/V2A brackets	30

Residual current device(RCD)

Assortment Schneider Electric	31
Assortment ABB	31
Assortment Doepke	31

Introduction

The GIFAS bestseller: power distributor made out of impact-resistant, age-resistant hard rubber.

You drink a dark brown, fizzy lemonade and automatically call it «coke», right? If you work in the electrical industry and need a socket distributor, you simply call it «GIFAS». You can't get more of a brand than that – we're proud of it!

GIFAS power distributors stand for maximum reliability, safety and efficiency. Whether for industrial applications, commercial buildings or your home: our solutions guarantee a stable and safe power supply. With flexible configuration options, our switchgear combinations offer the perfect symbiosis of performance and adaptability.

What characterises our power distributors

- all the advantages of hard rubber*, for example:
 - temperature, weather, UV and ozone resistant
 - silicone and halogen free
 - good resistance to acids and alkalis
 - high electrical insulation capacity
 - self-extinguishing and flame retardant
 - no condensation
 - high vibration, shock and jarring resistance
- engravable
- large standard range (see following pages), various types available from stock or
- fitting according to your specifications (small and large series production)
- fuse elements protected by transparent, impact-resistant covers
- VA screws embedded in rustproof brass press-in bushes with double anchors
- protection class up to IP65 possible (depending on fitting)
- different enclosure sizes
- versions with and without advanced rain protection roof
- internal, separate mounting channels for direct wall mounting
- various suspension/mounting brackets and different stand versions available
- service-friendly design, many spare parts available

*GIFAS uses a synthetic polymer SBR rubber as the starting material. The raw material, in the form of granules or strips, is vulcanised under high pressure and at high temperature on our own machines to create the final form of the workpiece. The vulcanisation process transforms the caoutchouc into rubber, which remains elastic and dimensionally stable, is not easily soluble and has very good thermal properties. This vulcanisation process is time-consuming and labour-intensive, but the excellent properties of the product are worth the effort.

- ✓ = from stock, offer subject to prior sale
- further versions on request
- various accessories and spare parts available

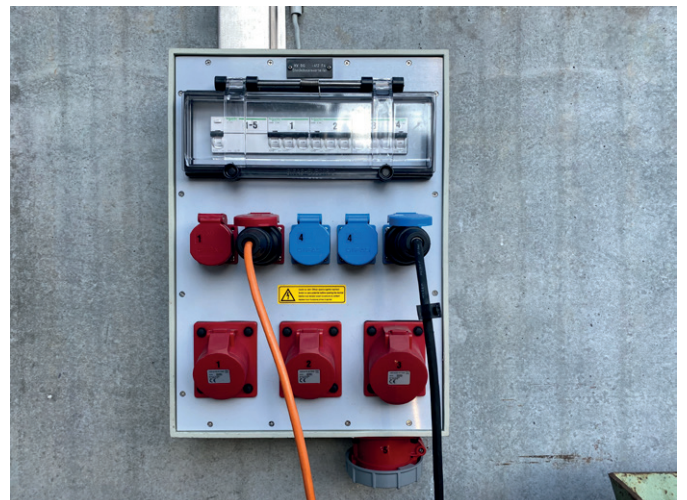

Hard rubber power distributors

Type 1400

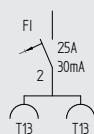

Item no.	228701 ✓
Output	2×T13
Input	1×SCG M20 bottom 1×blind plug M20 top
Max. pre-fuse	13A
Housing material	hard rubber
Protection category	IP55
Housing colour	black
Dimensions	78×290×65 mm
Remarks	without internal mounting channels

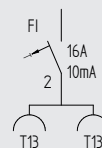

Item no.	228702 ✓
Output	2×T13
Input	1×SCG M20 top
Max. pre-fuse	13A
Housing material	hard rubber
Protection category	IP55
Housing colour	black
Dimensions	78×290×65 mm
Remarks	without internal mounting channels

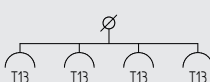

Item no.	228703 ✓
Output	4×T13
Input	1×SCG M20 right
Max. pre-fuse	13A
Housing material	hard rubber
Protection category	IP55
Housing colour	black
Dimensions	290×78×65 mm
Remarks	without internal mounting channels

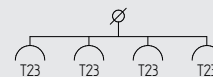

Item no.	234453 ✓
Output	4×T23
Input	1×SCG M20 right
Max. pre-fuse	16A
Housing material	hard rubber
Protection category	IP55
Housing colour	black
Dimensions	290×78×65 mm
Remarks	without internal mounting channels

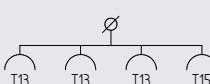

Item no.	228705
Output	3×T13 1×T15
Input	1×SCG M20 right
Max. pre-fuse	13A
Housing material	hard rubber
Protection category	IP55
Housing colour	black
Dimensions	290×78×65 mm
Remarks	without internal mounting channels

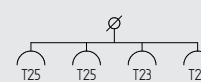

Item no.	228704 ✓
Output	2×T23 2×T25
Input	1×SCG M20 right
Max. pre-fuse	16A
Housing material	hard rubber
Protection category	IP55
Housing colour	black
Dimensions	290×78×65 mm
Remarks	without internal mounting channels

Accessories

263262 Mounting plate set V2A for distributor type 1400, incl. screws

263263 Mounting bracket set V2A for distributor type 1400, incl. screws

Hard rubber power distributors

Type 1600

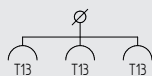

Item no.	228706 ✓
Output	3×T13
Input	1×SCG M20 right
Max. pre-fuse	13A
Housing material	hard rubber
Protection category	IP55
Housing colour	black
Dimensions	199×82×62 mm
Remarks	without internal mounting channels

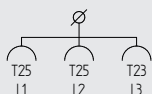

Item no.	228708 ✓
Output	1×T23 2×T25
Input	1×SCG M20 right
Max. pre-fuse	16A
Housing material	hard rubber
Protection category	IP55
Housing colour	black
Dimensions	199×82×62 mm
Remarks	without internal mounting channels

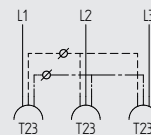

Item no.	228707 ✓
Output	3×T23
Input	1×SCG M20 left
Max. pre-fuse	16A
Housing material	hard rubber
Protection category	IP55
Housing colour	black
Dimensions	199×82×62 mm
Remarks	without internal mounting channels

Accessories

263264 Mounting bracket set V2A for distributor type 1600, incl. screws

Hard rubber power distributors

Type 1616

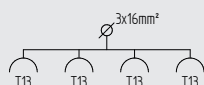
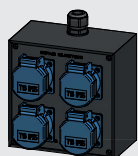

Item no.	228734 ✓
Output	4×T13
Input	1×SCG M20 top
Max. pre-fuse	13A
Housing material	hard rubber
Protection category	IP55
Housing colour	black
Dimensions	160×160×90 mm
Remarks	4 internal mounting channels

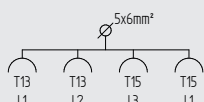
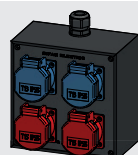

Item no.	228735 ✓
Output	2×T13 2×T15
Input	1×SCG M20 top
Max. pre-fuse	13A
Housing material	hard rubber
Protection category	IP55
Housing colour	black
Dimensions	160×160×90 mm
Remarks	4 internal mounting channels

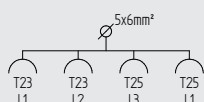
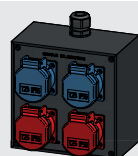

Item no.	228736 ✓
Output	2×T23 2×T25
Input	1×SCG M20 top
Max. pre-fuse	16A
Housing material	hard rubber
Protection category	IP55
Housing colour	black
Dimensions	160×160×90 mm
Remarks	4 internal mounting channels

Type 2516

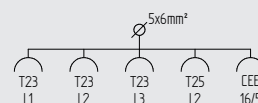
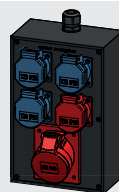

Item no.	228737 ✓
Output	3×T23 1×T25 1×CEE 16/5
Input	1×SCG M20 top
Max. pre-fuse	16A
Housing material	hard rubber
Protection category	IP44
Housing colour	black
Dimensions	161×251×90 mm
Remarks	4 internal mounting channels

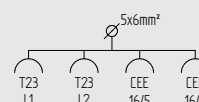
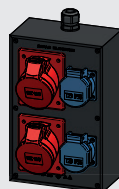

Item no.	228738 ✓
Output	2×T23 2×CEE 16/5
Input	1×SCG M20 top
Max. pre-fuse	16A
Housing material	hard rubber
Protection category	IP44
Housing colour	black
Dimensions	161×251×90 mm
Remarks	4 internal mounting channels

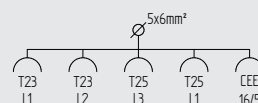
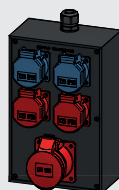

Item no.	228739 ✓
Output	2×T23 2×T25 1×CEE 16/5
Input	1×SCG M20 top
Max. pre-fuse	16A
Housing material	hard rubber
Protection category	IP44
Housing colour	black
Dimensions	161×251×90 mm
Remarks	4 internal mounting channels

Accessories

263265 Mounting bracket set V2A for distributor type 1616, incl. screws

Accessories

263266 Mounting bracket set V2A for distributor type 2516, incl. screws

Hard rubber power distributors

Type 2612

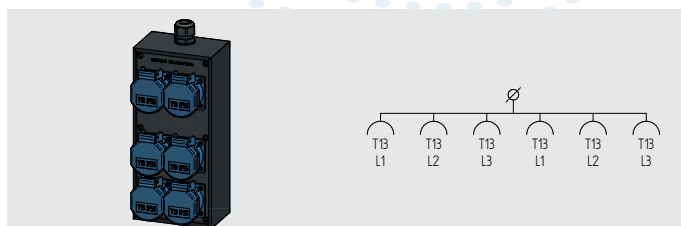

Item no.	228709 ✓
Output	6×T13
Input	1×SCG M20 top
Max. pre-fuse	13A
Housing material	hard rubber
Protection category	IP55
Housing colour	black
Dimensions	120×261×75.5 mm
Remarks	without internal mounting channels

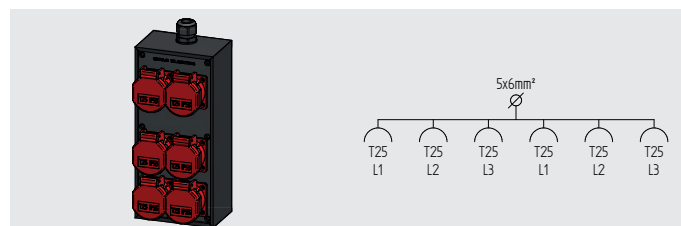

Item no.	228710 ✓
Output	6×T25
Input	1×SCG M20 top
Max. pre-fuse	16A
Housing material	hard rubber
Protection category	IP55
Housing colour	black
Dimensions	120×261×75.5 mm
Remarks	without internal mounting channels

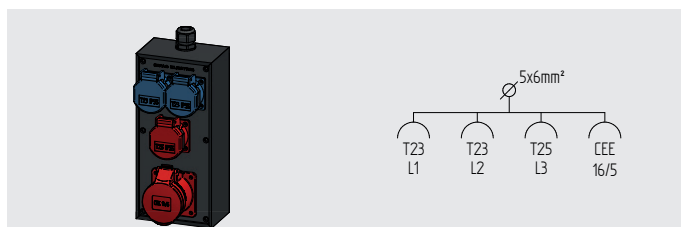

Item no.	228711 ✓
Output	2×T23 1×T25 1×CEE 16/5
Input	1×SCG M20 top
Max. pre-fuse	16A
Housing material	hard rubber
Protection category	IP44
Housing colour	black
Dimensions	120×261×75.5 mm
Remarks	without internal mounting channels

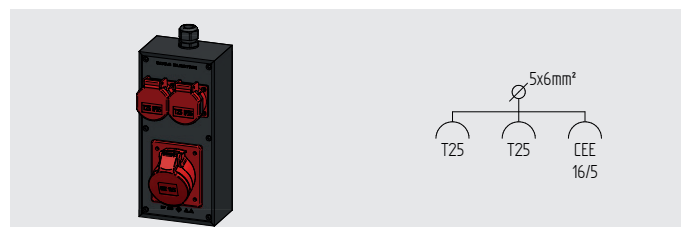

Item no.	228712 ✓
Output	2×T25 1×CEE 16/5
Input	1×SCG M20 top
Max. pre-fuse	16A
Housing material	hard rubber
Protection category	IP44
Housing colour	black
Dimensions	120×261×75.5 mm
Remarks	without internal mounting channels

Accessories

263267 Mounting bracket set V2A for distributor type 2612, incl. screws

Hard rubber power distributors

Type 2700

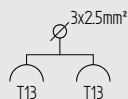
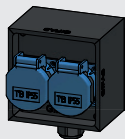

Item no.	228731 ✓
Output	2×T13
Input	1×SCG M20 bottom
Max. pre-fuse	13A
Housing material	hard rubber
Protection category	IP55
Housing colour	black
Dimensions	111×111×79 mm
Remarks	without internal mounting channels

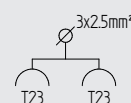
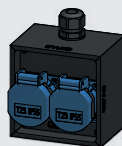

Item no.	234826
Output	2×T23
Input	1×SCG M20 top
Max. pre-fuse	16A
Housing material	hard rubber
Protection category	IP55
Housing colour	black
Dimensions	111×111×79 mm
Remarks	without internal mounting channels

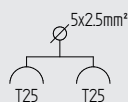
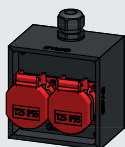

Item no.	228733 ✓
Output	2×T25
Input	1×SCG M20 top
Max. pre-fuse	16A
Housing material	hard rubber
Protection category	IP55
Housing colour	black
Dimensions	111×111×79 mm
Remarks	without internal mounting channels

Hard rubber power distributors

Type 2812

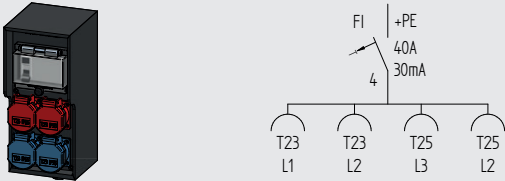

Item no.	228740 ✓
Output	2×T23 2×T25
Input	1×SCG M20 bottom
Max. pre-fuse	16A
Housing material	hard rubber
Protection category	IP55
Housing colour	black
Dimensions	120×269×133 mm
Remarks	4 internal mounting channels

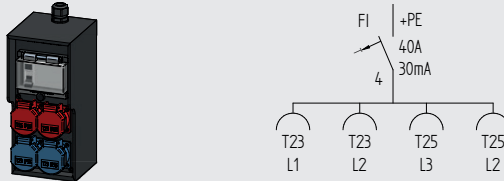

Item no.	228741 ✓
Output	2×T23 2×T25
Input	1×SCG M20 top
Max. pre-fuse	16A
Housing material	hard rubber
Protection category	IP55
Housing colour	black
Dimensions	120×269×133 mm
Remarks	4 internal mounting channels



Item no.	228742 ✓
Output	1×T23 1×CEE 16/5
Input	1×SCG M20 top
Max. pre-fuse	16A
Housing material	hard rubber
Protection category	IP44
Housing colour	black
Dimensions	120×269×133 mm
Remarks	4 internal mounting channels



Item no.	228743 ✓
Output	1×T25 1×CEE 16/5
Input	1×SCG M20 top
Max. pre-fuse	16A
Housing material	hard rubber
Protection category	IP44
Housing colour	black
Dimensions	120×269×133 mm
Remarks	4 internal mounting channels

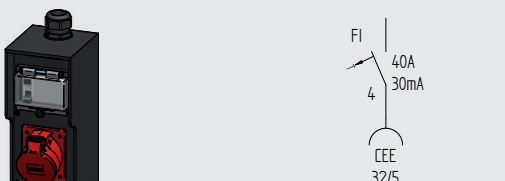

Item no.	033433 ✓
Output	1×CEE 32/5
Input	1×SCG M32 top
Max. pre-fuse	32A
Housing material	hard rubber
Protection category	IP44
Housing colour	black
Dimensions	120×269×133 mm
Remarks	4 internal mounting channels

Hard rubber power distributors

Type 3020

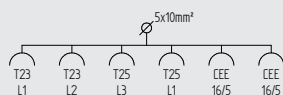
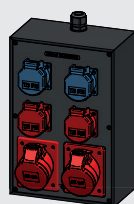

Item no.	228744 ✓
Output	2×T23 2×T25 2×CEE 16/5
Input	1×SCG M20 top
Max. pre-fuse	16A
Housing material	hard rubber
Protection category	IP44
Housing colour	black
Dimensions	202×302×110 mm
Remarks	4 internal mounting channels

Type 3800

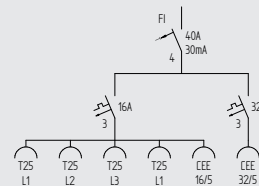
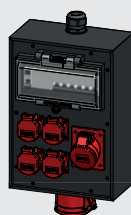

Item no.	228802 ✓
Output	4×T25 1×CEE 16/5 1×CEE 32/5
Input	1×SCG M32 top
Max. pre-fuse	63A
Housing material	hard rubber
Protection category	IP44
Housing colour	black
Dimensions	252×362×133 mm
Remarks	4 internal mounting channels

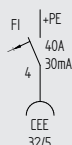

Item no.	057025
Output	1×CEE 32/5
Input	1×SCG M32 top
Max. pre-fuse	32A
Housing material	hard rubber
Protection category	IP44
Housing colour	black
Dimensions	202×302×110 mm
Remarks	4 internal mounting channels

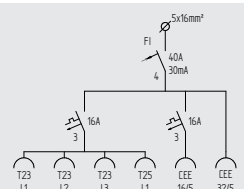
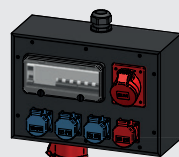

Item no.	228803
Output	3×T23 1×T25 1×CEE 16/5 1×CEE 32/5
Input	1×SCG M32 top
Max. pre-fuse	32A
Housing material	hard rubber
Protection category	IP44
Housing colour	black
Dimensions	362×252×133 mm
Remarks	4 internal mounting channels

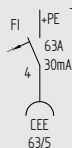

Item no.	033434
Output	1×CEE 63/5
Input	1×SCG M40 top
Max. pre-fuse	63A
Housing material	hard rubber
Protection category	IP44
Housing colour	black
Dimensions	202×302×110 mm
Remarks	4 internal mounting channels

Hard rubber power distributors

Type 3900

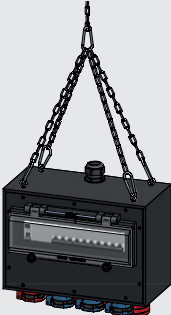
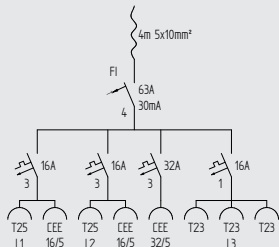
Item no.	228804
Output	3×T23 2×T25 2×CEE 16/5 1×CEE 32/5
Input	1×SCG M32 top
Max. pre-fuse	63A
Housing material	hard rubber
Protection category	IP44
Housing colour	black
Dimensions	362×252×173 mm
Remarks	with chain suspension 3 m

Item no.	228806 ✓
Output	2×T23 1×T25 1×CEE 16/5 1×CEE 32/5 1×CEE 63/5
Input	1×SCG M40 top
Max. pre-fuse	63A
Housing material	hard rubber
Protection category	IP44
Housing colour	black
Dimensions	252×362×173 mm
Remarks	4 internal mounting channels

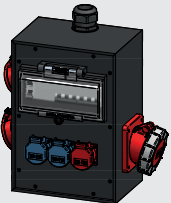
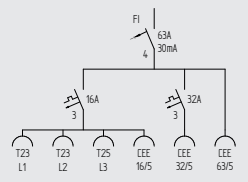
Hard rubber power distributors

Type 4512

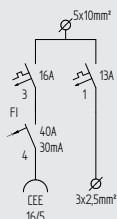

Item no.	040134
Output	1×CEE 16/5
Input	1×SCG M20 top 1×SCG M32 bottom
Max. pre-fuse	63A
Housing material	hard rubber
Protection category	IP65
Housing colour	black
Dimensions	120×454×144 mm
Remarks	Mounting options: see accessories

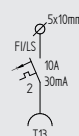

Item no.	228810
Output	1×T13
Input	2×SCG M32 bottom
Max. pre-fuse	63A
Housing material	hard rubber
Protection category	IP55
Housing colour	black
Dimensions	120×454×144 mm
Remarks	Mounting options: see accessories

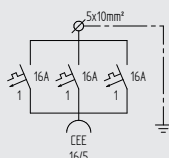

Item no.	032456
Output	1×CEE 16/5
Input	1×SCG M16 bottom 1×SCG M32 bottom
Max. pre-fuse	80A
Housing material	hard rubber
Protection category	IP65
Housing colour	grau
Dimensions	120×454×144 mm
Remarks	Mounting options: see accessories

Accessories/spare parts

- 043283** ✓ Special supports (zinc-plated steel)
- 035198** Concrete base, pre-fabricated as a shaft top section, inner tube Ø300 mm
- 027444** ✓ Covering cap PE 1050×Ø315, inner Ø296 mm
- 040105** ✓ Covering cap PE 800×225, inner Ø210 mm
- 044552** ✓ Filter mat, white, Ø302 mm (as insect protection)
- 021826** ✓ Filter mat, white, Ø214 mm (as insect protection)
- 030871** ✓ V4A strap set, L+R (wall mounting)
- 051653** Mounting plate V4A (wall/tube mounting)
- 052654** Shackle V4A for 53 mm tube (fits mounting plate)
- 052656** ✓ Shackle V4A for 65 mm tube (fits mounting plate)
- 054768** Mast fixing V4A for 60 mm tube (two mast fixing are required per distribution box)
- 052426** Mast fixing V4A for 76 mm tube (two mast fixing are required per distribution box)

Hard rubber power distributors

Type 7200

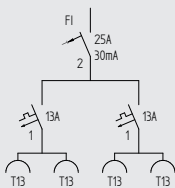
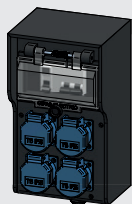

Item no.	228767 ✓
Output	4×T13
Input	1×SCG M20 bottom
Max. pre-fuse	40A
Housing material	hard rubber
Protection category	IP55
Housing colour	black
Dimensions	160×280×132 mm
Remarks	4 internal mounting channels

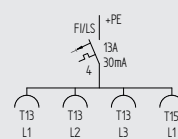
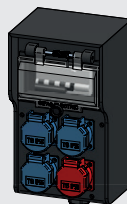

Item no.	228768
Output	3×T13 1×T15
Input	1×SCG M25 bottom
Max. pre-fuse	40A
Housing material	hard rubber
Protection category	IP55
Housing colour	black
Dimensions	160×280×132 mm
Remarks	4 internal mounting channels

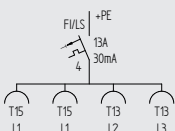
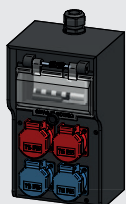

Item no.	228769 ✓
Output	2×T13 2×T15
Input	1×SCG M25 top
Max. pre-fuse	80A
Housing material	hard rubber
Protection category	IP55
Housing colour	black
Dimensions	160×280×132 mm
Remarks	4 internal mounting channels

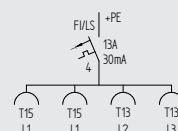
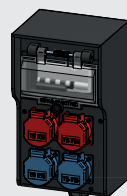

Item no.	228770 ✓
Output	2×T13 2×T15
Input	1×SCG M25 bottom
Max. pre-fuse	80A
Housing material	hard rubber
Protection category	IP55
Housing colour	black
Dimensions	160×280×132 mm
Remarks	4 internal mounting channels

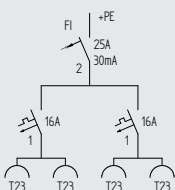
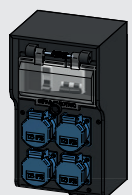

Item no.	228771
Output	4×T23
Input	1×SCG M20 bottom
Max. pre-fuse	40A
Housing material	hard rubber
Protection category	IP55
Housing colour	black
Dimensions	160×280×132 mm
Remarks	4 internal mounting channels

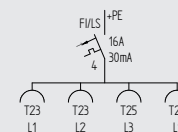
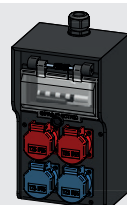

Item no.	228772 ✓
Output	2×T23 2×T25
Input	1×SCG M25 top
Max. pre-fuse	40A
Housing material	hard rubber
Protection category	IP55
Housing colour	black
Dimensions	160×280×132 mm
Remarks	4 internal mounting channels

Hard rubber power distributors

Type 7200

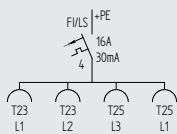
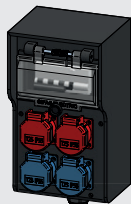

Item no.	228773 ✓
Output	2×T23 2×T25
Input	1×SCG M25 bottom
Max. pre-fuse	40 A
Housing material	hard rubber
Protection category	IP55
Housing colour	black
Dimensions	160×280×132 mm
Remarks	4 internal mounting channels

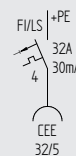

Item no.	040099
Output	1×CEE 32/5
Input	1×SCG M32 top
Max. pre-fuse	63 A
Housing material	hard rubber
Protection category	IP44
Housing colour	black
Dimensions	160×280×132 mm
Remarks	4 internal mounting channels

Hard rubber power distributors

Type 7250

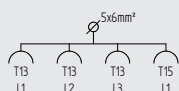
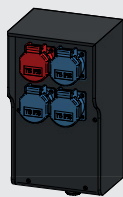

Item no.	228775
Output	3×T13 1×T15
Input	1×SCG M20 bottom
Max. pre-fuse	13A
Housing material	hard rubber
Protection category	IP55
Housing colour	black
Dimensions	160×280×132 mm
Remarks	4 internal mounting channels

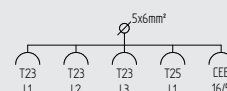
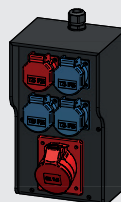

Item no.	228774 ✓
Output	3×T23 1×T25
Input	1×SCG M20 top
Max. pre-fuse	16A
Housing material	hard rubber
Protection category	IP44
Housing colour	black
Dimensions	160×280×132 mm
Remarks	4 internal mounting channels

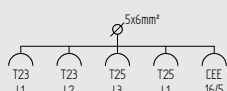
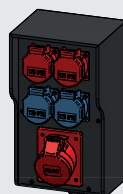

Item no.	228776 ✓
Output	2×T23 2×T25 1×CEE 16/5
Input	1×SCG M20 bottom
Max. pre-fuse	16A
Housing material	hard rubber
Protection category	IP44
Housing colour	black
Dimensions	160×280×132 mm
Remarks	4 internal mounting channels

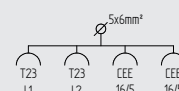
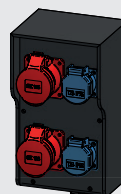

Item no.	228777 ✓
Output	2×T23 2×CEE 16/5
Input	1×SCG M20 bottom
Max. pre-fuse	16A
Housing material	hard rubber
Protection category	IP44
Housing colour	black
Dimensions	160×280×132 mm
Remarks	4 internal mounting channels

Hard rubber power distributors

Type 7300

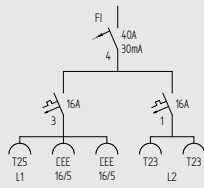
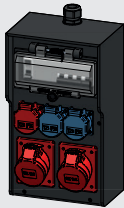

Item no.	228778 ✓
Output	2×T23 1×T25 2×CEE 16/5
Input	1×SCG M25 top
Max. pre-fuse	63A
Housing material	hard rubber
Protection category	IP44
Housing colour	black
Dimensions	200×350×134 mm
Remarks	4 internal mounting channels

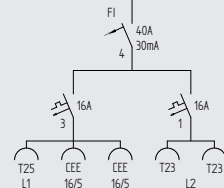

Item no.	228779 ✓
Output	2×T23 1×T25 2×CEE 16/5
Input	1×SCG M25 bottom
Max. pre-fuse	63A
Housing material	hard rubber
Protection category	IP44
Housing colour	black
Dimensions	200×350×134 mm
Remarks	4 internal mounting channels

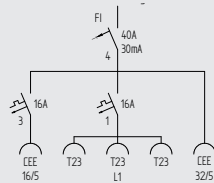
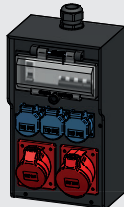

Item no.	228780 ✓
Output	3×T23 1×CEE 16/5 1×CEE 32/5
Input	1×SCG M32 top
Max. pre-fuse	32A
Housing material	hard rubber
Protection category	IP44
Housing colour	black
Dimensions	200×350×134 mm
Remarks	4 internal mounting channels

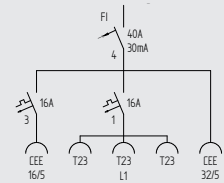
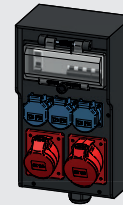

Item no.	228781 ✓
Output	3×T23 1×CEE 16/5 1×CEE 32/5
Input	1×SCG M32 bottom
Max. pre-fuse	32A
Housing material	hard rubber
Protection category	IP44
Housing colour	black
Dimensions	200×350×134 mm
Remarks	4 internal mounting channels

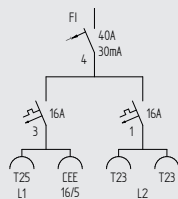
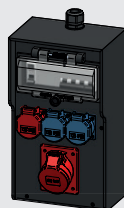

Item no.	228782 ✓
Output	2×T23 1×T25 1×CEE 16/5
Input	1×SCG M25 top
Max. pre-fuse	40A
Housing material	hard rubber
Protection category	IP44
Housing colour	black
Dimensions	200×350×134 mm
Remarks	4 internal mounting channels

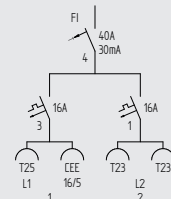
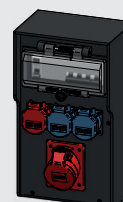

Item no.	228783 ✓
Output	2×T23 1×T25 1×CEE 16/5
Input	1×SCG M25 bottom
Max. pre-fuse	40A
Housing material	hard rubber
Protection category	IP44
Housing colour	black
Dimensions	200×350×134 mm
Remarks	4 internal mounting channels

Hard rubber power distributors

Type 7300

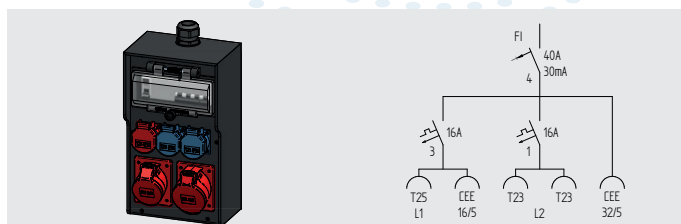

Item no.	228784 ✓
Output	2×T23 1×T25 1×CEE 16/5 1×CEE 32/5
Input	1×SCG M32 top
Max. pre-fuse	32A
Housing material	hard rubber
Protection category	IP44
Housing colour	black
Dimensions	200×350×134 mm
Remarks	4 internal mounting channels

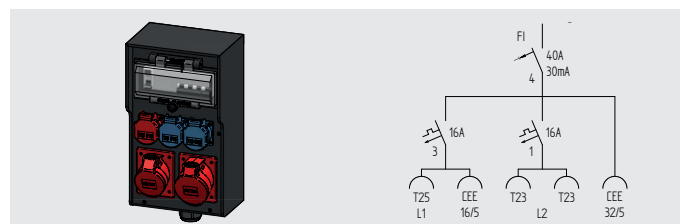

Item no.	228785 ✓
Output	2×T23 1×T25 1×CEE 16/5 1×CEE 32/5
Input	1×SCG M32 bottom
Max. pre-fuse	32A
Housing material	hard rubber
Protection category	IP44
Housing colour	black
Dimensions	200×350×134 mm
Remarks	4 internal mounting channels

Hard rubber power distributors

Type 7400

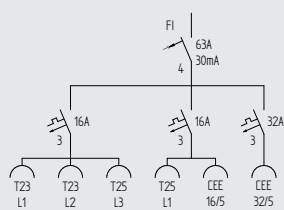
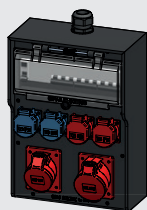

Item no.	228403 ✓
Output	2×T23 2×T25 1×CEE 16/5 1×CEE 32/5
Input	1×SCG M32 top
Max. pre-fuse	63A
Housing material	hard rubber
Protection category	IP44
Housing colour	black
Dimensions	267×371×133 mm
Remarks	4 internal mounting channels

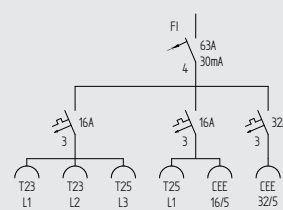
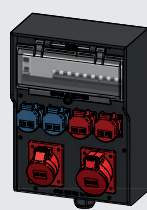

Item no.	228404 ✓
Output	2×T23 2×T25 1×CEE 16/5 1×CEE 32/5
Input	1×SCG M32 bottom
Max. pre-fuse	63A
Housing material	hard rubber
Protection category	IP44
Housing colour	black
Dimensions	267×371×133 mm
Remarks	4 internal mounting channels

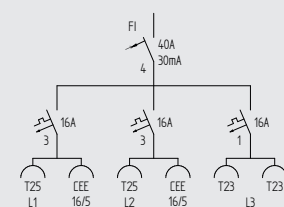
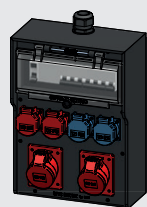

Item no.	228345 ✓
Output	2×T23 2×T25 2×CEE 16/5
Input	1×SCG M32 top
Max. pre-fuse	40A
Housing material	hard rubber
Protection category	IP44
Housing colour	black
Dimensions	267×371×133 mm
Remarks	4 internal mounting channels

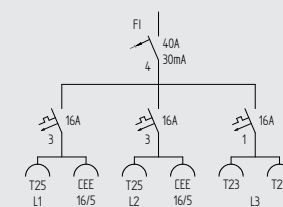
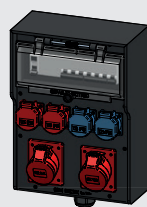

Item no.	228346 ✓
Output	2×T23 2×T25 2×CEE 16/5
Input	1×SCG M32 bottom
Max. pre-fuse	40A
Housing material	hard rubber
Protection category	IP44
Housing colour	black
Dimensions	267×371×133 mm
Remarks	4 internal mounting channels

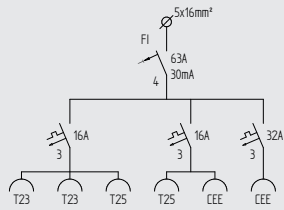
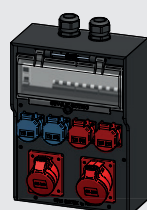

Item no.	228347 ✓
Output	2×T23 2×T25 1×CEE 16/5 1×CEE 32/5
Input	2×SCG M32 top
Max. pre-fuse	63A
Housing material	hard rubber
Protection category	IP44
Housing colour	black
Dimensions	267×371×133 mm
Remarks	4 internal mounting channels

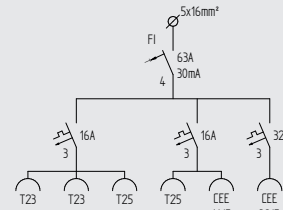
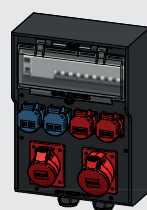

Item no.	228348 ✓
Output	2×T23 2×T25 1×CEE 16/5 1×CEE 32/5
Input	2×SCG M32 bottom
Max. pre-fuse	63A
Housing material	hard rubber
Protection category	IP44
Housing colour	black
Dimensions	267×371×133 mm
Remarks	4 internal mounting channels

Hard rubber power distributors

Type 7400

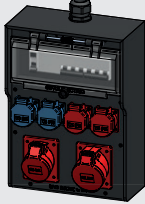
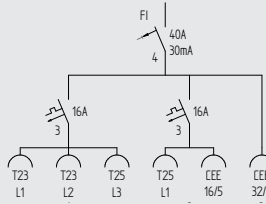
Item no.	228402 ✓
Output	2×T23 2×T25 1×CEE 16/5 1×CEE 32/5
Input	1×SCG M32 top
Max. pre-fuse	32A
Housing material	hard rubber
Protection category	IP44
Housing colour	black
Dimensions	267×371×133 mm
Remarks	4 internal mounting channels

Item no.	228350 ✓
Output	2×T23 2×T25 1×CEE 16/5 1×CEE 32/5
Input	1×SCG M32 bottom
Max. pre-fuse	32A
Housing material	hard rubber
Protection category	IP44
Housing colour	black
Dimensions	267×371×133 mm
Remarks	4 internal mounting channels

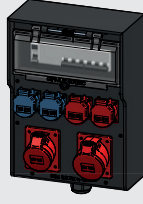
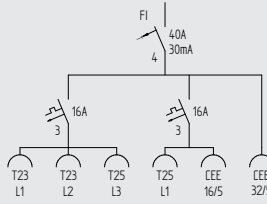
Item no.	228351 ✓
Output	2×T23 2×T25 1×CEE 16/5 1×CEE 32/5
Input	1×SCG M32 top
Max. pre-fuse	63A
Housing material	hard rubber
Protection category	IP44
Housing colour	grau
Dimensions	267×371×133 mm
Remarks	4 internal mounting channels

Item no.	228352 ✓
Output	2×T23 2×T25 1×CEE 16/5 1×CEE 32/5
Input	1×SCG M32 bottom
Max. pre-fuse	63A
Housing material	hard rubber
Protection category	IP44
Housing colour	grau
Dimensions	267×371×133 mm
Remarks	4 internal mounting channels

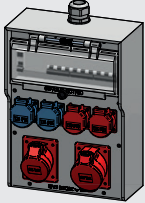
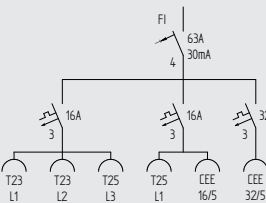
Item no.	228700 ✓
Output	4×T23 2×T25 2×CEE 16/5 1×CEE 32/5
Input	1×SCG M32 bottom
Max. pre-fuse	32A
Housing material	hard rubber
Protection category	IP44
Housing colour	grau
Dimensions	267×371×133 mm
Remarks	4 internal mounting channels

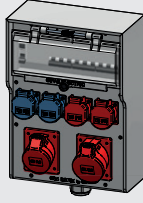
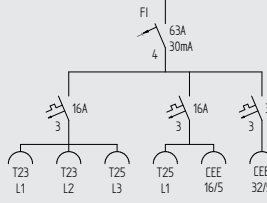
Hard rubber power distributors

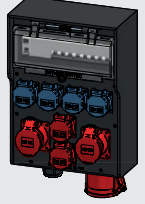
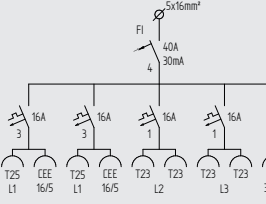
Type 7700

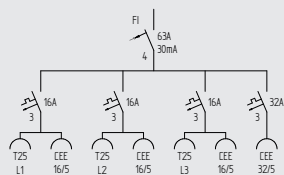
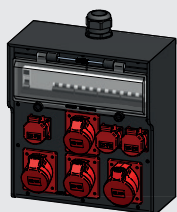

Item no.	228671 ✓
Output	3×T25 3×CEE 16/5 1×CEE 32/5
Input	1×SCG M40 top
Max. pre-fuse	63A
Housing material	hard rubber
Protection category	IP44
Housing colour	black
Dimensions	336×370×190 mm
Remarks	4 internal mounting channels

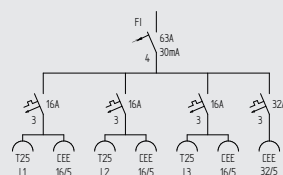
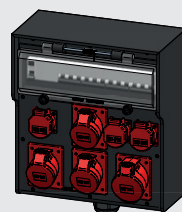

Item no.	228673 ✓
Output	3×T25 3×CEE 16/5 1×CEE 32/5
Input	1×SCG M40 bottom
Max. pre-fuse	63A
Housing material	hard rubber
Protection category	IP44
Housing colour	black
Dimensions	336×370×190 mm
Remarks	4 internal mounting channels

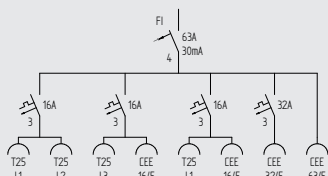
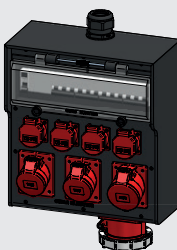

Item no.	228406 ✓
Output	4×T25 2×CEE 16/5 1×CEE 32/5 1×CEE 63/5
Input	1×SCG M40 top
Max. pre-fuse	63A
Housing material	hard rubber
Protection category	IP44
Housing colour	black
Dimensions	336×370×190 mm
Remarks	4 internal mounting channels

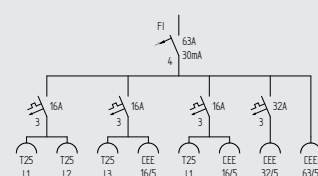
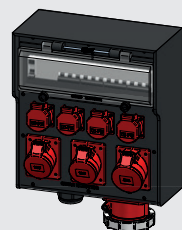

Item no.	228674 ✓
Output	4×T25 2×CEE 16/5 1×CEE 32/5 1×CEE 63/5
Input	1×SCG M40 bottom
Max. pre-fuse	63A
Housing material	hard rubber
Protection category	IP44
Housing colour	black
Dimensions	336×370×190 mm
Remarks	4 internal mounting channels

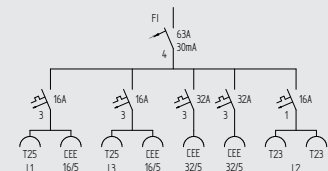
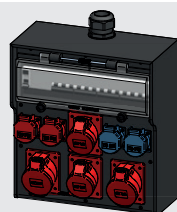

Item no.	228792 ✓
Output	2×T23 2×T25 2×CEE 16/5 2×CEE 32/5
Input	1×SCG M40 top
Max. pre-fuse	63A
Housing material	hard rubber
Protection category	IP44
Housing colour	black
Dimensions	336×370×190 mm
Remarks	4 internal mounting channels

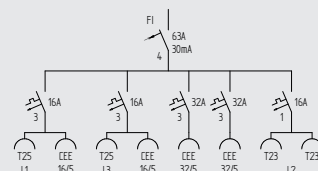
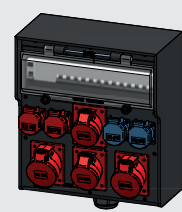

Item no.	228793 ✓
Output	2×T23 2×T25 2×CEE 16/5 2×CEE 32/5
Input	1×SCG M40 bottom
Max. pre-fuse	63A
Housing material	hard rubber
Protection category	IP44
Housing colour	black
Dimensions	336×370×190 mm
Remarks	4 internal mounting channels

Hard rubber power distributors

Type 7700

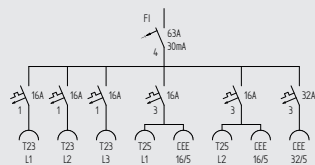
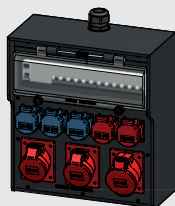

Item no.	228794 ✓
Output	3×T23 2×T25 2×CEE 16/5 1×CEE 32/5
Input	1×SCG M32 top
Max. pre-fuse	80A
Housing material	hard rubber
Protection category	IP44
Housing colour	black
Dimensions	336×370×190 mm
Remarks	4 internal mounting channels

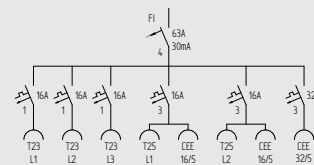
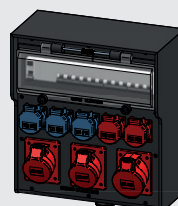

Item no.	228795 ✓
Output	3×T23 2×T25 2×CEE 16/5 1×CEE 32/5
Input	1×SCG M32 bottom
Max. pre-fuse	80A
Housing material	hard rubber
Protection category	IP44
Housing colour	black
Dimensions	336×370×190 mm
Remarks	4 internal mounting channels

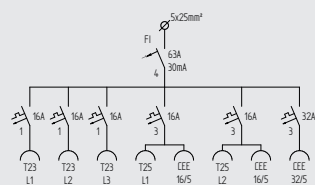
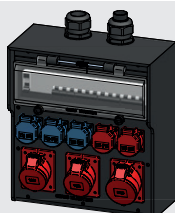

Item no.	228796 ✓
Output	3×T23 2×T25 2×CEE 16/5 1×CEE 32/5
Input	2×SCG M40 top
Max. pre-fuse	80A
Housing material	hard rubber
Protection category	IP44
Housing colour	black
Dimensions	336×370×190 mm
Remarks	4 internal mounting channels

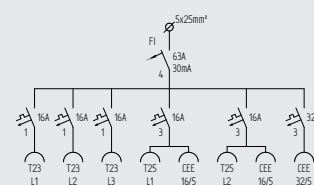
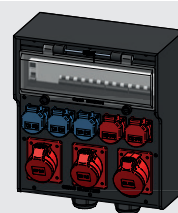

Item no.	228797 ✓
Output	3×T23 2×T25 2×CEE 16/5 1×CEE 32/5
Input	2×SCG M40 bottom
Max. pre-fuse	80A
Housing material	hard rubber
Protection category	IP44
Housing colour	black
Dimensions	336×370×190 mm
Remarks	4 internal mounting channels

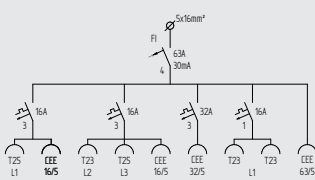
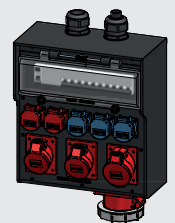

Item no.	228799 ✓
Output	3×T23 2×T25 2×CEE 16/5 1×CEE 32/5 1×CEE 63/5
Input	2×SCG M40 top
Max. pre-fuse	63A
Housing material	hard rubber
Protection category	IP44
Housing colour	black
Dimensions	336×370×190 mm
Remarks	4 internal mounting channels

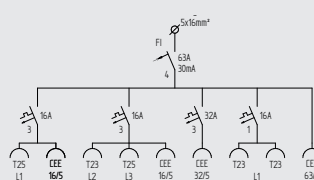
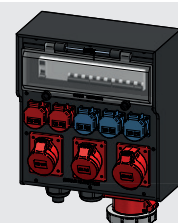

Item no.	228798 ✓
Output	3×T23 2×T25 2×CEE 16/5 1×CEE 32/5 1×CEE 63/5
Input	2×SCG M40 bottom
Max. pre-fuse	63A
Housing material	hard rubber
Protection category	IP44
Housing colour	black
Dimensions	336×370×190 mm
Remarks	4 internal mounting channels

Hard rubber power distributors

Type 7700

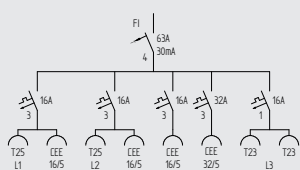
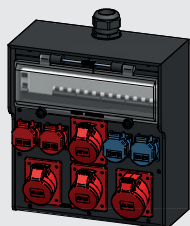

Item no.	228800 ✓
Output	2×T23 2×T25 3×CEE 16/5 1×CEE 32/5
Input	1×SCG M40 top
Max. pre-fuse	63A
Housing material	hard rubber
Protection category	IP44
Housing colour	black
Dimensions	336×370×190 mm
Remarks	4 internal mounting channels

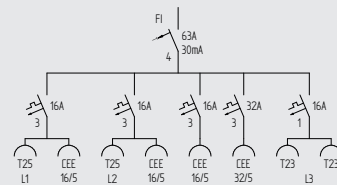
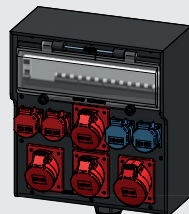

Item no.	228801 ✓
Output	2×T23 2×T25 3×CEE 16/5 1×CEE 32/5
Input	1×SCG M40 bottom
Max. pre-fuse	63A
Housing material	hard rubber
Protection category	IP44
Housing colour	black
Dimensions	336×370×190 mm
Remarks	4 internal mounting channels

Hard rubber power distributors

Type 7800

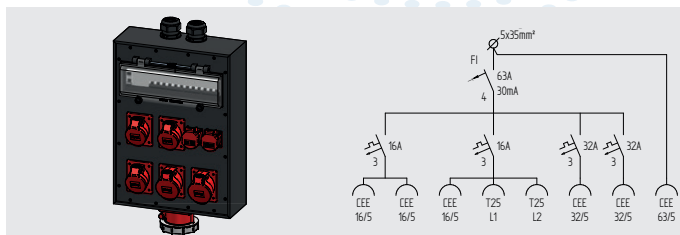

Item no.	228807 ✓
Output	2×T25 3×CEE 16/5 2×CEE 32/5 1×CEE 63/5
Input	2×SCG M40 top
Max. pre-fuse	63 A
Housing material	hard rubber
Protection category	IP44
Housing colour	black
Dimensions	362×503×133 mm
Remarks	4 internal mounting channels

Type 7900

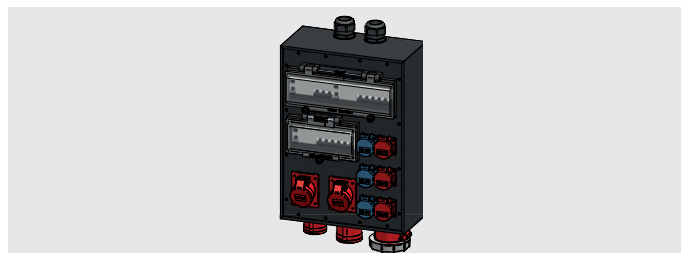

Item no.	228808 ✓
Output	3×T23 3×T25 3×CEE 16/5 1×CEE 32/5 1×CEE 63/5
Input	2×SCG M40 top
Max. pre-fuse	80 A
Housing material	hard rubber
Protection category	IP44
Housing colour	black
Dimensions	362×503×173 mm
Remarks	4 internal mounting channels

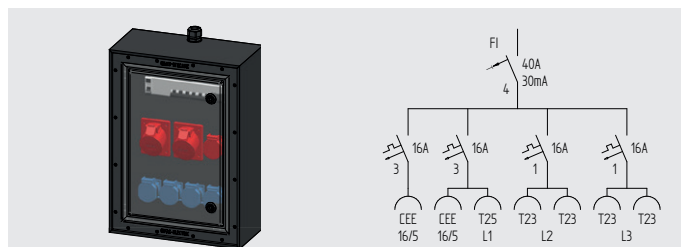

Item no.	228809
Output	4×T23 1×T25 2×CEE 16/5
Input	1×SCG M25 top
Max. pre-fuse	63 A
Housing material	hard rubber
Protection category	IP54
Housing colour	black
Dimensions	362×503×173 mm
Remarks	4 internal mounting channels

Suspended distributor, plastic

Suspended distributor, plastic

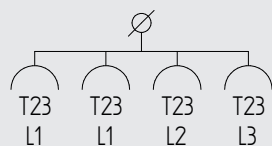
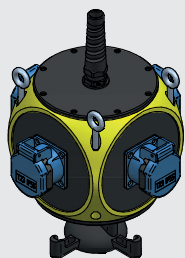

Item no.	227302 ✓
Output	4×T23
Input	1×SCG M20
Max. pre-fuse	16A
Housing material	plastic
Protection category	IP44
Housing colour	yellow/black
Dimensions	143×149×143 mm
Remarks	<ul style="list-style-type: none"> – excl. suspension (e.g. hanging set) – up to six mounting surfaces – for sockets up to max. CEE 32A

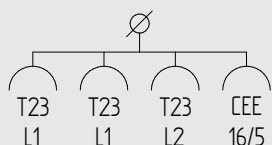
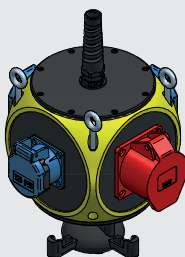

Item no.	227303
Output	3×T23 1×CEE 16/5
Input	1×SCG M20
Max. pre-fuse	16A
Housing material	plastic
Protection category	IP44
Housing colour	yellow/black
Dimensions	143×149×143 mm
Remarks	<ul style="list-style-type: none"> – excl. suspension (e.g. hanging set) – up to six mounting surfaces – for sockets up to max. CEE 32A

Suspended distributor, plastic with compressed air

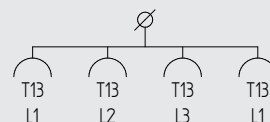
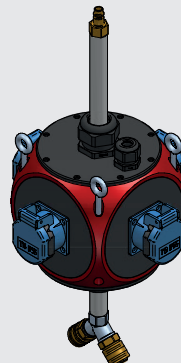

Item no.	227304 ✓
Output	4×T13 2×compressed air 3/8"
Input	1×SCG M20 1×compressed air 3/8"
Max. pre-fuse	13A
Housing material	plastic
Protection category	IP44
Housing colour	red/black
Dimensions	143×149×143 mm
Remarks	<ul style="list-style-type: none"> – exlc. suspension (e.g. hanging set) – up to six mounting surfaces – for sockets up to max. CEE 32A

Accessories/spare parts

043014 ✓ Link chain V4A rust-free Ø3/26 mm

043015 ✓ Link chain V4A rust-free with screw connection L = 32 mm (inside), Ø 4 mm

167265 ✓ Suspension kit steel zinc-plated (L = 300 mm)

Dimensions

Type 1400

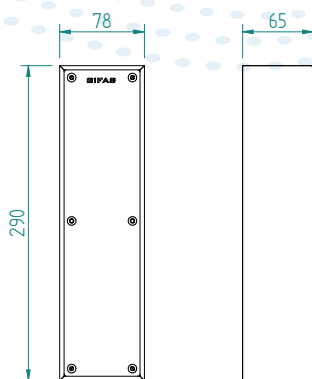

Type 1600

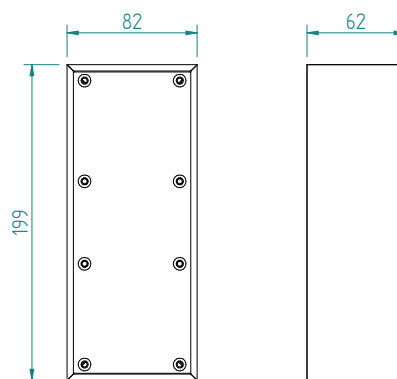

Type 1616

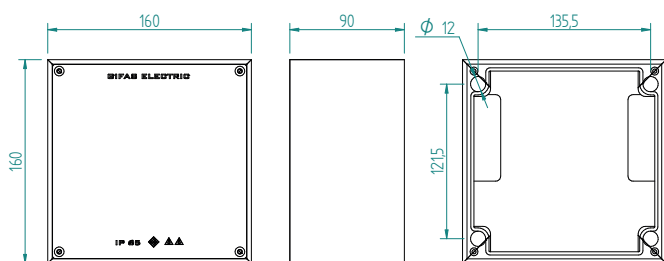

Type 2516

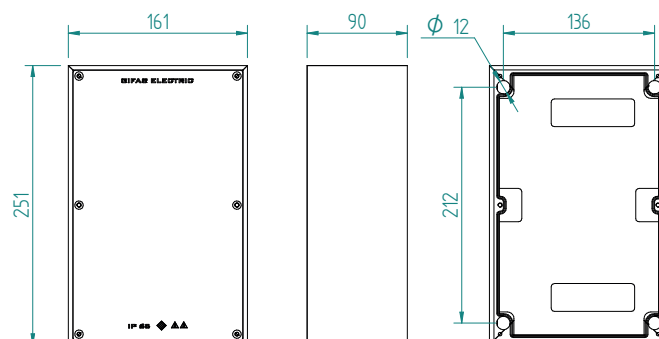

Type 2612

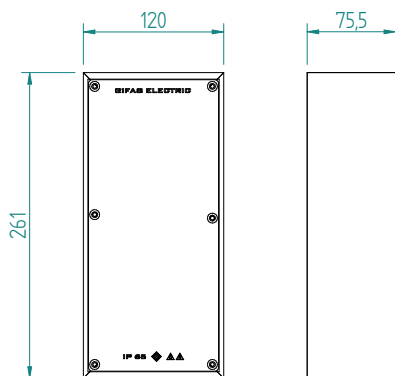

Type 2700

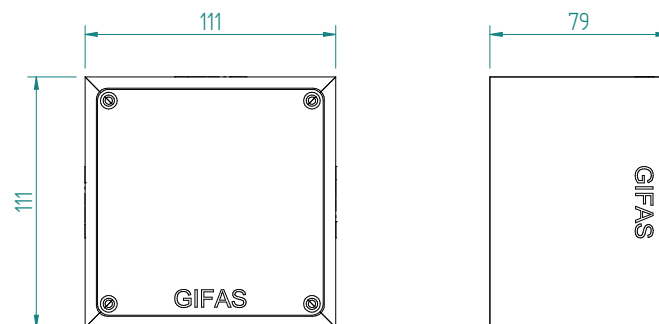

Type 2812

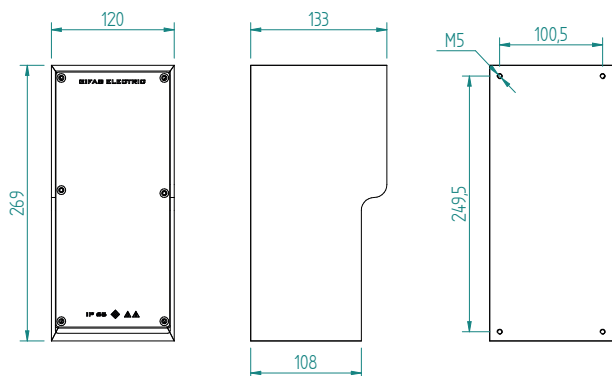

Type 3020

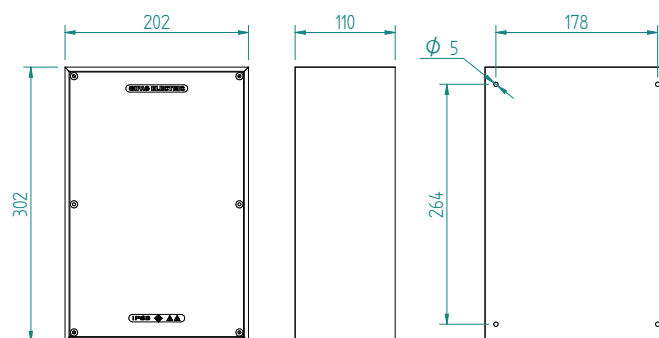

Dimensions

Type 3800

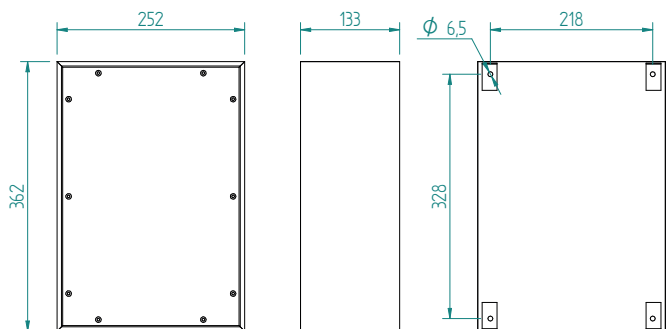

Type 3900

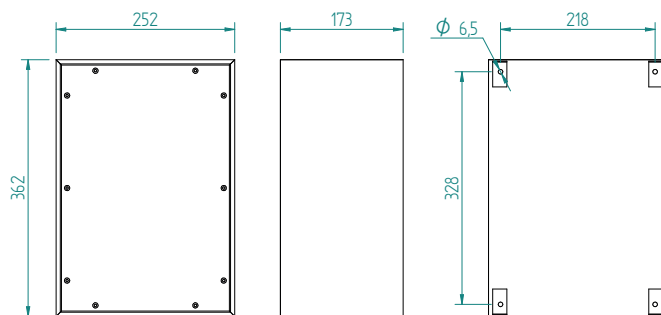

Type 4512

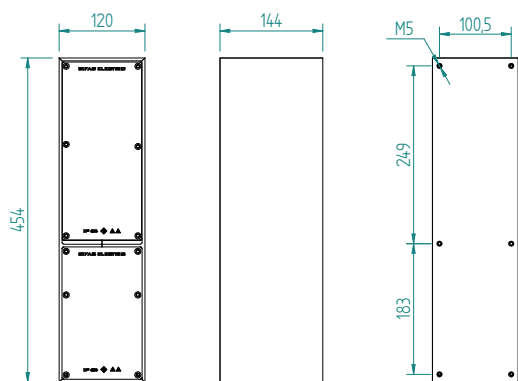

Type 7200

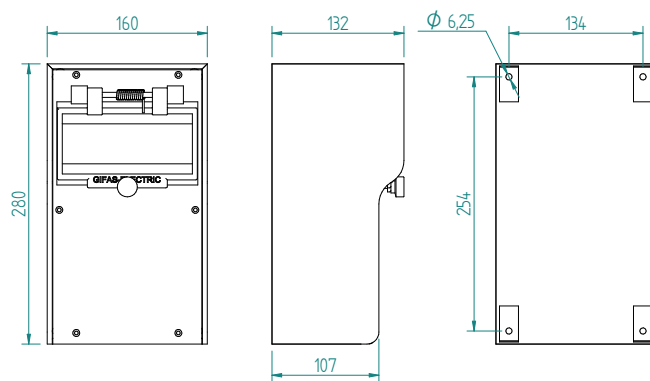

Type 7250

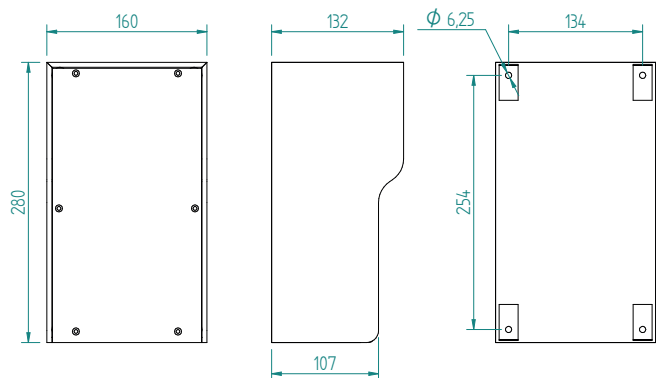

Type 7300

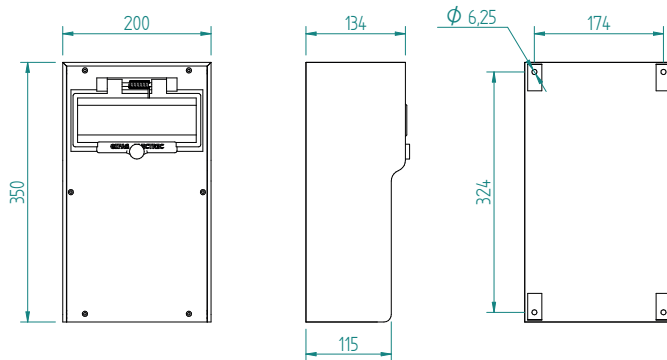

Type 7400

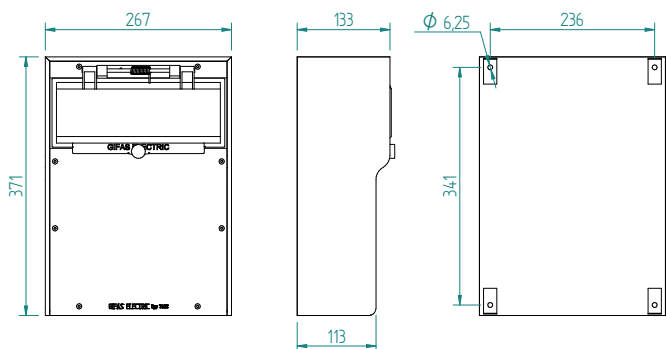

Type 7700

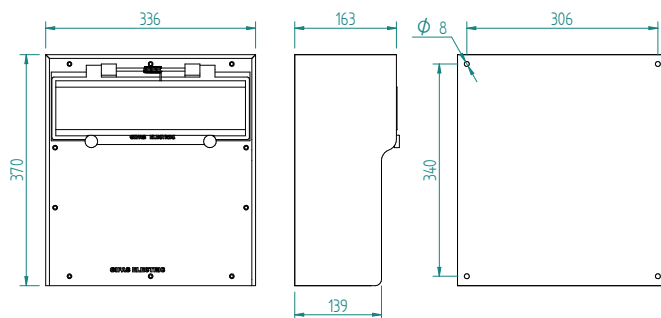

Dimensions

Type 7800

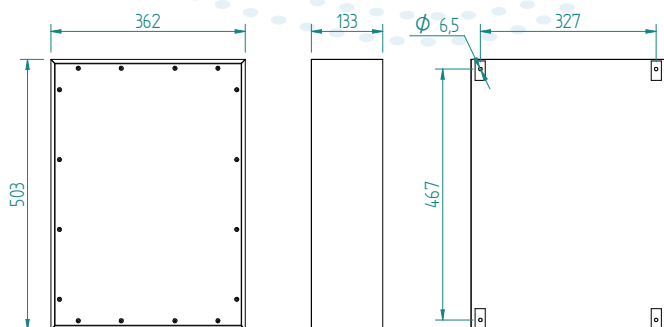

Type 7900

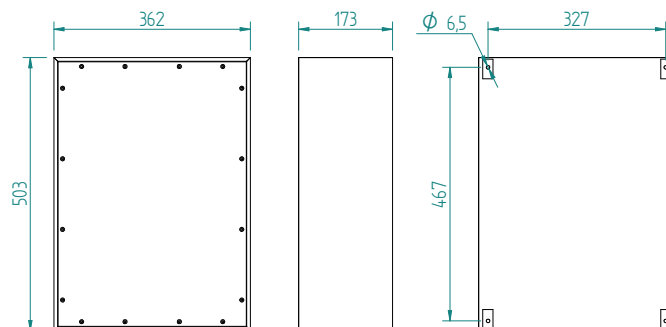

Suspended distributor, plastic

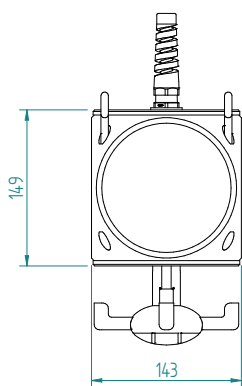

Suspended distributor, plastic with compressed air

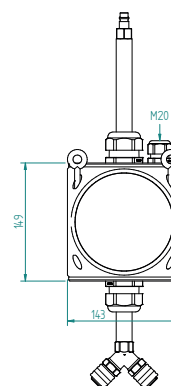

Frame

example

Item no.	042111
Designation	Frame type KA stainless steel V2A, suitable for GIFAS hard rubber housing type 2516
Overall height	1'200 mm
Bottom flange	200×200mm ²
Remark	other versions regarding material and dimensions available on request

example

Item no.	043577
Designation	Frame type GE stainless steel V4A, suitable for GIFAS hard rubber housing type 7300
Overall height	700 mm
Bottom flange	200×200mm ²
Remark	other versions regarding material and dimensions available on request

example

Item no.	245216
Designation	Frame type OF st 37 hot-dip galvanised, suitable for GIFAS hard rubber housing type 7400
Overall height	870 mm
Bottom flange	250×250mm ²
Remark	other versions regarding material and dimensions available on request

example

Item no.	244432
Designation	Frame type OF with pitched roof, St 37 hot-dip galvanised, suitable for GIFAS hard rubber housing type 7800
Overall height	1'000 mm
Bottom flange	300×300mm ²
Remark	other versions regarding material and dimensions available on request

Automated unit protective caps

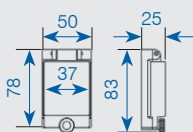

Item no.	011384 ✓
Designation	Protective cap 2 modules, B 37 mm
Remark	with knurled screw = IP65

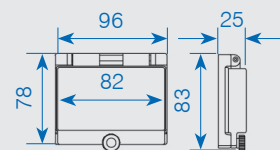
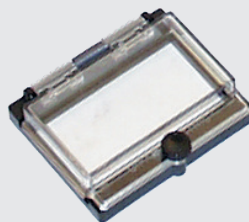

Item no.	050109 ✓
Designation	Protective cap 4.5 modules, B 82 mm
Remark	with knurled screw = IP65

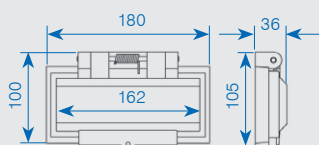

Item no.	011387 ✓
Designation	Protective cap 9 modules, B 162 mm
Remark	with knurled screw = IP65

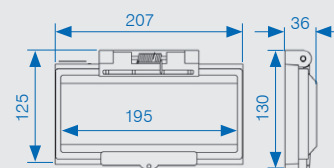

Item no.	011388 ✓
Designation	Protective cap 10.5 modules, B 195 mm
Remark	with knurled screw = IP65

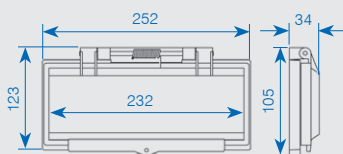

Item no.	011392 ✓
Designation	Protective cap 13 modules, B 232 mm
Remark	with knurled screw = IP65

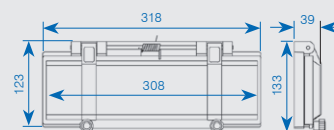

Item no.	043710 ✓
Designation	Protective cap 17 modules, B 308 mm
Remark	with knurled screw = IP65



Item no.	019522 ✓
Designation	Knurled screw M4×20 mm

Suspension/mounting brackets

Aluminium bracket



Assortment

- 029461** ✓ Aluminium bracket for type 7200, 20×380×5 mm, 2 units are required per housing
- 029462** ✓ Aluminium bracket for type 7300, 20×420×5 mm, 2 units are required per housing
- 029466** ✓ Aluminium Lasche zu Type 7400, 30×460×5 mm, 2 units are required per housing
- 049131** ✓ Aluminium bracket for type 7700, 30×470×5 mm, 2 units are required per housing
- 050782** ✓ Aluminium bracket for type 7800, 30×600×5 mm, 2 units are required per housing

V4A/V2A bracket



Assortment

- 041180** ✓ Rust-free V4A bracket for type 2812, 15×310×3 mm, 2 units are required per housing
- 048746** ✓ Rust-free V4A bracket for type 7200, 20×340×3 mm, 2 units are required per housing
- 046546** ✓ Rust-free V4A bracket for type 7300, 20×410×3 mm, 2 units are required per housing
- 043431** ✓ Rust-free V4A bracket for type 7400/7700, 20×460×3 mm, 2 units are required per housing
- 013253** ✓ Rust-free V4A bracket for type 7800, 20×580×3 mm, 2 units are required per housing

Residual current device(RCD)

Assortment Schneider Electric



Assortment

- 144943 ✓ RCD type A 3N - 40A/30mA
- 144944 ✓ RCD type A 3N - 63A/30mA
- 013747 ✓ RCD type A 3N - 80A/30mA
- 039558 ✓ RCD type A 3N - 63A/300mA
- 060043 ✓ RCD type A 3N - 63A/300mA, selectively
- 259737 RCD type A 3N - 125A/300mA, selectively
- 128749 RCD type B 3N - 40A/30mA, AC-DC sensitive
- 104686 RCD type B 3N - 63A/30mA, AC-DC sensitive
- 128750 ✓ RCD type B 3N - 63A/300mA, AC-DC sensitive

Assortment ABB



Assortment

- 232228 ✓ RCD type A 3N - 63A/300mA
- 232229 ✓ RCD type A 3N - 63A/300mA, selectively
- 214154 ✓ RCD type A 3N - 125A/300mA
- 031044 ✓ RCD type B 3N - 40A/30mA, AC-DC sensitive, short time-delayed
- 165008 ✓ RCD type B 3N - 63A/30mA, AC-DC sensitive, short time-delayed
- 165450 ✓ RCD type B 3N - 63A/300mA, AC-DC sensitive
- 214155 ✓ RCD type B 3N - 125A/300mA, AC-DC sensitive

Assortment Doepke



Assortment

- 237393 ✓ RCD type B SK HD 63A/300mA 4L
- 237394 ✓ RCD type B SK HD 125A/300mA 4L

Assortment ISKRA



Assortment

- 257974 ✓ RCD type A 3N-125A/300mA, selectively
- 257978 ✓ RCD type B 3N-125A/300mA, AC-DC sensitive

GIFAS
ELECTRIC



**THE
SOLUTION
PARTNER**

GIFAS-ELECTRIC GmbH
Dietrichstrasse 2
CH-9424 Rheineck

+41 71 886 44 44
info@gifas.ch
www.gifas.ch